

PREFACE

We are very appreciated that you elect and purchase this kind of pedal motorcycle of The kind of motorcycle is made in processing by advanced equipments and processing, assembling by excellent parts. It is the best popular pedal high grade motorcycle and suitable to drive in the city with performance as follows: large power, low oil-consuming and noise, electric ignition, electric starting, frame with protecting weld, speed up with actively, actively driving and excellent function.

The book contains the correct operation and simply maintaining to durable. Any difference against real motorcycle, please do as per the real. We have the right to change any contents in it without notice.

In order to make your safety and drive with comfortable, please you carefully read the book before driving. And hope you have a good trip.

Catalogue

1. Notice items for safely driving.....	1	Inspection for steering bar.....	22
Way of driving.....	2	Inspection braking.....	23
Loading.....	3	Inspection for braking light.....	24
2. All parts name.....	4	Inspection for turn signal.....	25
3. All parts operation.....	5	Inspection for wheel.....	26
Speedometer assy	6	Inspection for front & rear damper.....	26
Indicator light.....	7	Inspection for head light,tail light,sidelight....	27
Main switch.....	8	Angle of speedometer,horn rear mirror.....	27
Starting button switch comp head light.....	8	Rear number plate,exhaust muffler.....	28
Changing switch comp head light horn button.....	8	Inspection for air cleaner.....	29
Switch comp turn signal.....	9	Exchanging for oil.....	29
Key comp turn signal.....	10	Exchanging for gear oil.....	29
Lock comp steering bar.....	11	Inspection for spark plug.....	30
Front luggage.....	12	6. Simply maintaining and adjusting.....	31
Eront starting.....	13	Stable for period maintaining items and time.....	32
Electric starting.....	14	Clear the battery head.....	33
Kick starting.....	14	Replace the fuse.....	34
4. Normal driving ways	15	Way of cleaning for air cleaner.....	35
Correctly drive.....	17	Adjusting carburetor and choke.....	36
Sparking way.....	20	7. Specification.....	37
5. Check before driving	21	8. lectric principal drawings.....	38
Inspection and adding for gasoline.....	22		

1. NOTICE ITEMS FOR SAFELY DRIVE

Please you keep natural and relaxing mood, wear com-fortable clothing when driving when driving. You drive the vehicle without worry and with relaxing Mood and carefully, especially obeying the traffic rules.

NOTICE

- Please the driver doesn't wear loosing or too long clothing to happen to accident.
- Forbid to touch with the skin of your body because the exhaust pipe has very high temperature after burn our in 10 minutes or the period of driving.
- Please keep the motorcycle away off the dry lawn or tinder to avoid to happen to damage.

Dress

- Tie the wristband well and wear orderly clothing when driving.
- Wear helmet and tie the bands well.

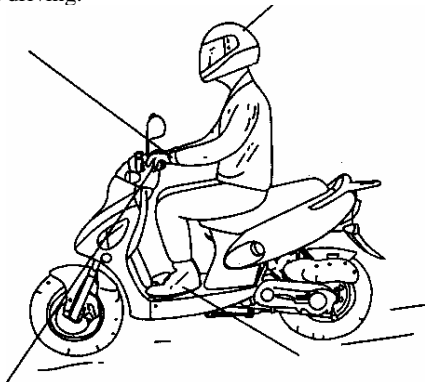

- Catch hold of the handle bar by hands, forbid to use the single handle bar.
- Wear smooth shoe for your safely driving.

■ Way of driving

- should only keep the natural guise to operate it with actively.

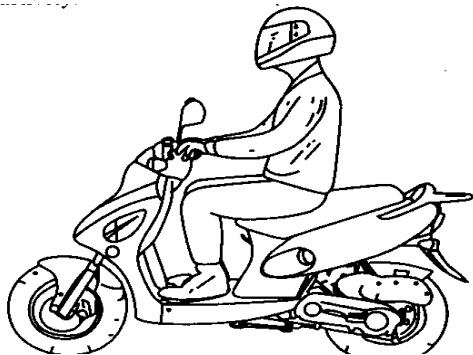

- Performance of safely operation is made effect to posi-tion of seat, so please seat the center, if not will happen to accident.

- The body should in the road when swerving,if not, will lose controlling



- Pay attention to driving the broken road or crush road. Firstly acknowledge the conditions on the accidented road, should reduce the speed, and relax the hand, shoulder and catch hold of bar of throttle.

LOADING

Please note that there had a difference of feel for handle between the loading and unloading.

The handle bar easily shakes when overtaking, so don't overtake.

- The max weight of front luggage:1.5Kg
- The max weight of lug-gage:10Kg

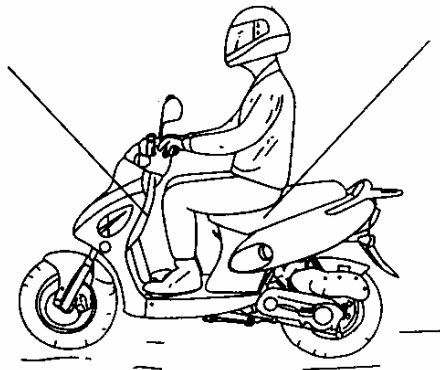

NOTICE

- Forbid to place the cloth under the seat,if not ,the engine work out of orderly because of choking for fuel system..
- Forbid to pace the cloth between the outer cover of frame and engine, if not, should make the engine broken.
- Don't place the goods in the luggage which don't appoint out in order to avoid to damage the outer cove of frame.

2.Part Name

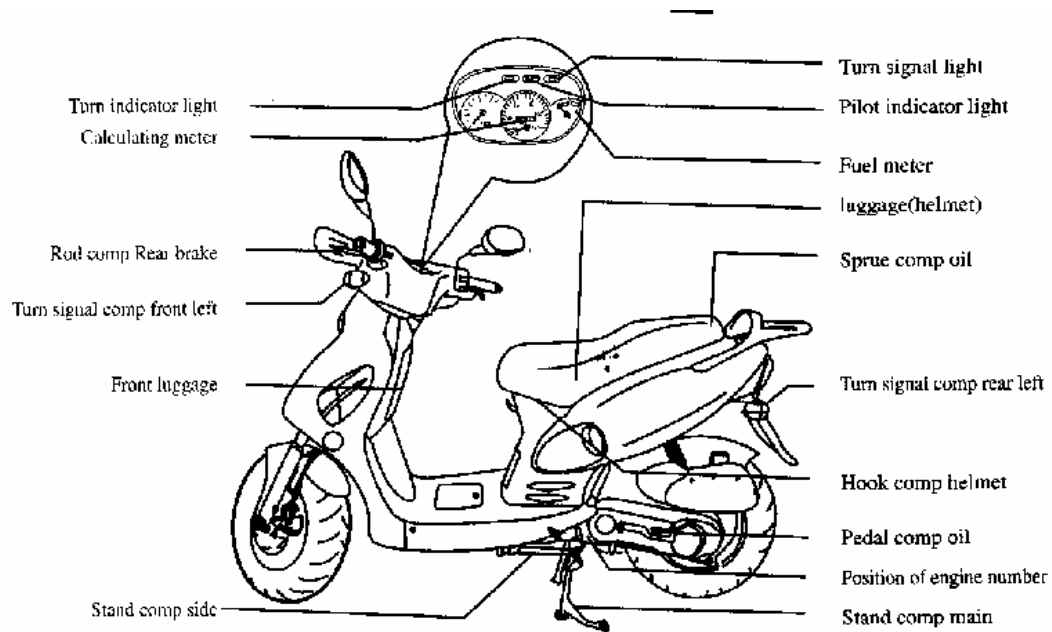

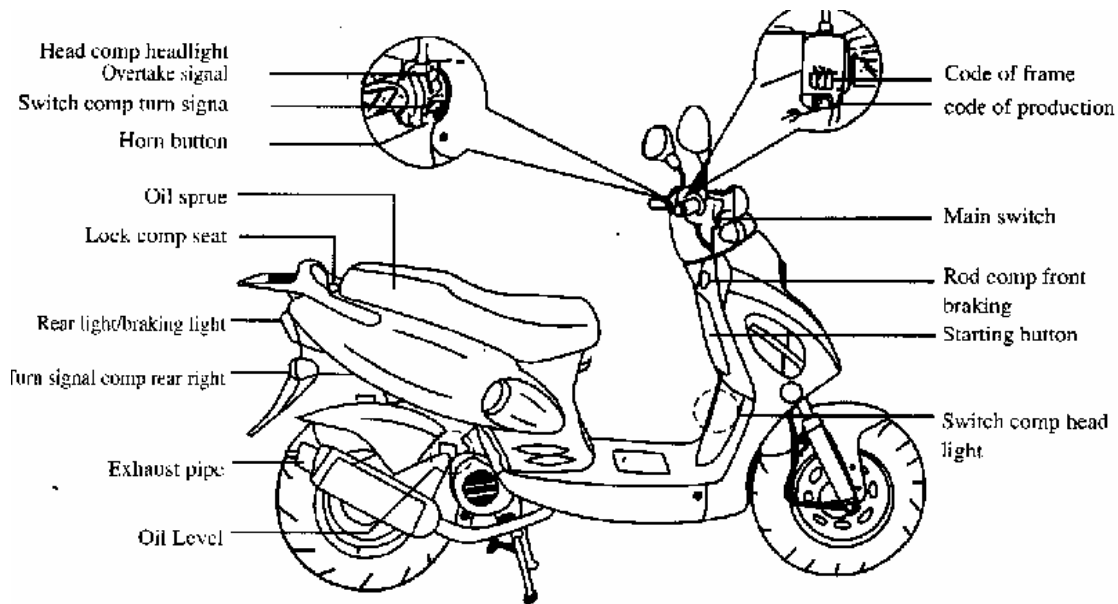

3. ALL PARTS OPERATION

■ SPEEDOMETER ASSY INDICATOR LIGHT

① Clock

The standard of running speed is by KM/H

② Mileage meter

③ Pilot indicator light

The light show pilot.

④ Turn signal

When operating the handle light, the indicator light is switched on.

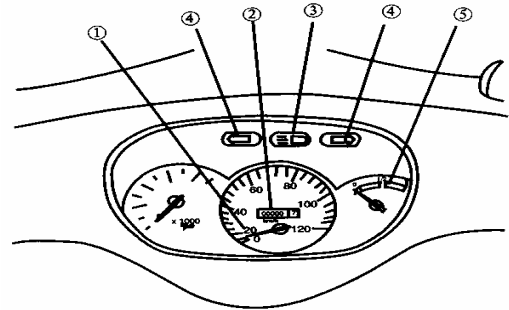

⑤ Fuel meter

It shows the capacity of oil in fuel tank,(The fuel reading is right when the main switch lie the “↷”,and the fuel reading doesn't show, when the main switch lie to “:⊗↷”).Please add up the 90# gasoline in time when the fuel hand shows the read area.

■ Main Switch

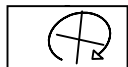

Engine electric resource is off and the
Engine stops working.

The key can be taken away.

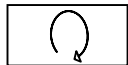

Engine electric resource is switched on
and the engine work.

When driving the key cant be take .
away.

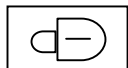

The steering bar is locked to avoid to
theft.

The key can be taken away.

NOTICE

- When sparking, must be lock the steering bar to avoid to theft.

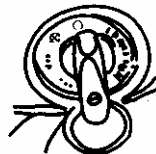

■ STARTING BUTTON

When using the electric button, must draw the rod of front braking or step urgently rear braking pedal until touch with the electric resource and start it.

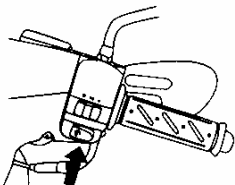

■ SWITCH COMP HEAD LIGHT



The headlight, sidelight and speedometer light are shut off at the same time.

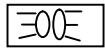

The sidelight and speedometer light are switched on. (But the engine don't start and the light is shut off)

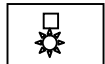

The headlight and speedometer light are switched on at the same time.

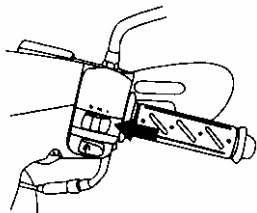

■ HEAD LIGHT CHANGE SWITCH

OVERTAKING SIGNAL SWITCH

The headlights light the changing switch of pilot and near light.



When pilot working, use the position.



Use it if the front vehicle appears or drive in the city.



When overtaking if front vehicle appears, constantly place the PASSING position for headlight, the Headlight can flash and warn the front vehicle.

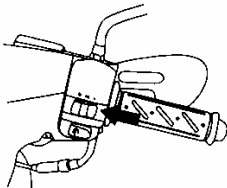

■ HORN BUTTON

Push down the horn button until noise when turn the main switch the “”

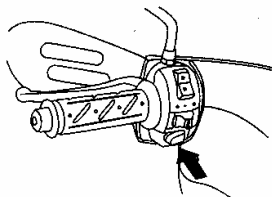

■ SWITCH COMP TURN SIGNAL

When swerve or change rail, use turn signal, and shut off switch until the light is switched on.



:when turns left, please use it



:when turns right, please use it.

When unchain, push down the turn signal changing switch only.

NOTICE

- because the turn signal don't unchain automatic, return it previous place after using, if not will happen accident.

- The turn signal doesn't operate automatic when the main switch on the position of

“”

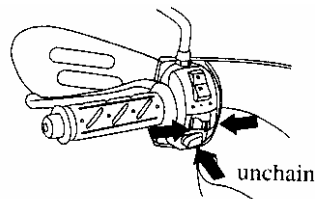

■ KEY OF HELMET

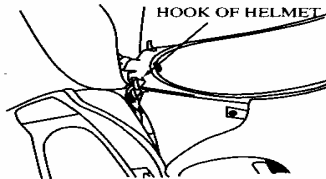

Way of using

- (1) Open lock comp seat and wrench it.
- (2) Make the mineral ring of helmet into the hook.
- (3) Put down the seat until lock it automatic.

Way of taking down

- Reference above ways.

NOTICE

- Must not hook the helmet in the vehicle to damage the pladtic.

■ Case of helmet

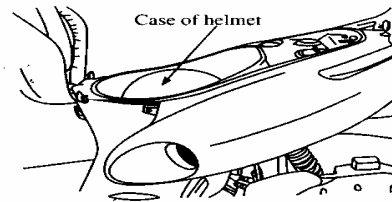

It lies under the seat

Way of taking away is reference the above(1)

- When replace the helmet, should make the jaw of helmet bottom.

NOTICE

- The max of loading doesn't excess 10kg,
- Confirm whether the seat can be locked.
- Forbid to place the lower-heat resistant goods, food and com-fusible into the luggage because of high temperature of engine,
- Forbid to place expensive gooks into it.
- Pay attention to cleaning to avoid making the water into it.

■ STEERING BAR LOCK

In order to theft, should lock the steering bar when parking.

(WAY OF LOCK)

Turn the steering bar left full and insert the key into the “  ”

WAY OF UNCHAIN

Turn the key to “  ” and automatic unchain.

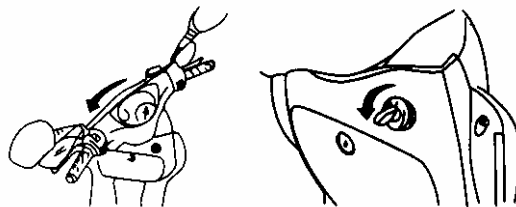

NOTICE

- After lock it, make the steering bar turn and check it lock well.
- Forbid to ruin the key to “ ” when driving, if not ,will happen to lose control steering bar.
- when parking,forbid to parking it the traffic place.

■ FRONT LUGGAGE

Way of opening

Insert the key and turn right till open.

Way of closing

Insert the key and turn right, and close front luggage cover, with taking out the key after turning left.

NOTICE

- The loading of front luggage doesn't exceed 1.5kg.
- Forbid to place the expensive into the case .
- Pay attention to clear to avoid making the water into case.

WAY FOR OPENING

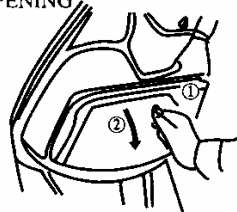

WAY FOR CLOSING

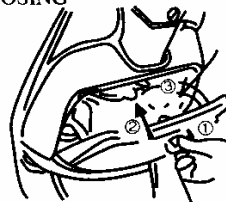

USING THE KEY WHEN CLOSING FRONT LUGGAGE

■ WAY OF STARTING FOR ENGINE

- ① Start engine before checking the gasoline, oil and battery.
- ② Support the main stand when starting engine and make the wheel leave away ground.
- ③ Turn the blank key to “ON”.

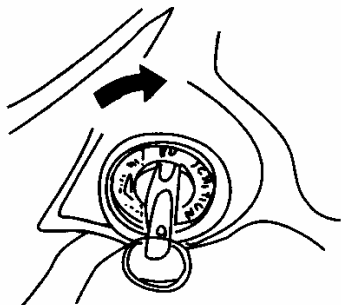

- ④ Can start it by electric or kick starting system, if adopt the electric starting, must catch hold of front braking or step rear braking pedal.

- ⑤ Turn the blank key to “OFF” when cold especially in winter. And step the starting rod about 5 times, pouring into a little gasoline, touching with electric line till starting, and speed up oil throttle, warming up 2-3 minutes.

NOTICE

- If there has not reach at 90# gasoline or use the motorcycle long before, and start to use it , please handle it per way of above (5).
- In order to extend the usage of new , should use kick starting to start.

- ⑥ When starting the period of warm, open the key and start it by electric starting system or kick starting system.

Because it is designed as advanced electric warm starting and starting valve of carburetor.
(ELECTRIC STARTING)

<ELECTRIC STARTING>

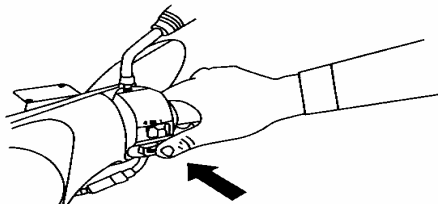

NOTICE

The hand leaves the button after starting engine, and don't touch with the button in running, rear braking light can light when catch hold of front braking bar or rear braking step .The time of catching doesn't exceed

3 minutes, and every other spare doesn't exceed 10 seconds.

<kick start>

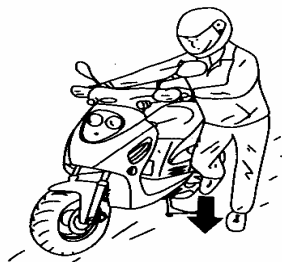

NOTICE

Return the starting rod to previous place after starting engine, if not, will effect on safely drive.

4.NORMALWAY OF DRIVE

Spring main stand firstly.

- Push the vehicle ahead and the main stand will spring automatic

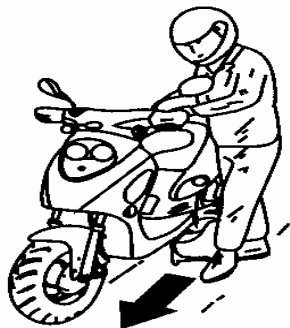

NOTICE

- Forbid to add up oil to run engine at high speed before starting engine but no driving.

- Put on the vehicle from left and seat well,at the same time the left foot touches with ground to avoid leaning.

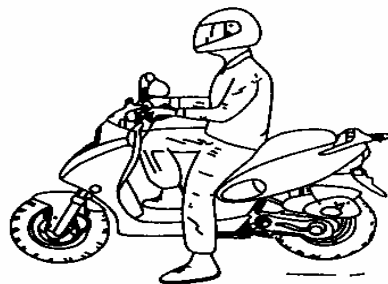

NTICE

- Rear braking should be kept the position of braking before driving.

2 UNCHAINING FOR REAR BRAKING

Loose rod of rear braking

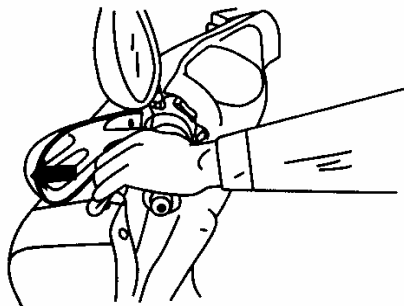

NOTICE

- Forbid to add up oil to the throttle bar after loose the pedal of rear braking pedal, avoid to rush and happen dangerous.

- 3 Turn the throttle bar slowly and the vehicle moves slowly.

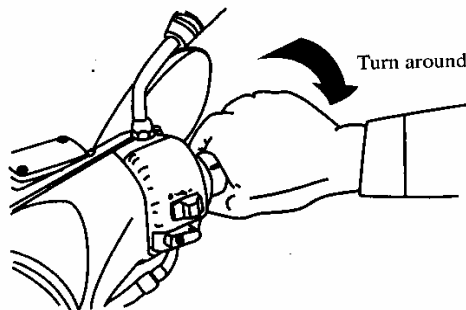

NOTICE

- Forbid to turn the throttle urgently in order to avoid to rush immediately.

4 CORRECTLY DRIVE

Open turn signal signal before driving and confirm safety of rear to move..

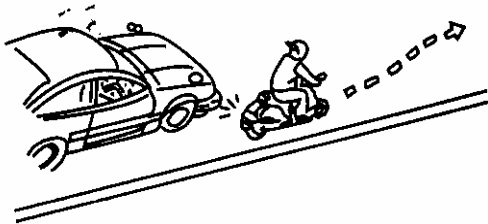

Adjusting speed controlled by throttle.

Return inner

...the speed become fast
Slowly add up oil.

The power will become when
Starting moving or climbing.
Slowly add up oil.

Return previous

...the speed will become slowly.

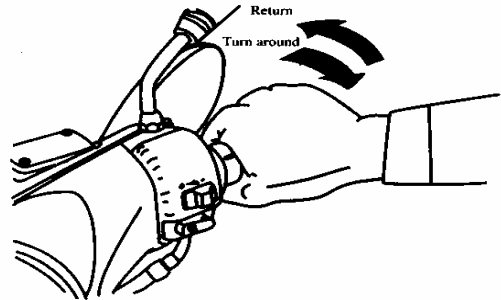

■ THE CORRECTLY DRIVING IN THE PERIOD OF NEW MESH WILL EFFECT ON ENGINE USAGE

• Please keep the speed 60km in the new period of 1500km, details are as follows:

MILEAGE KM	0-300	300-500	500-1000	1000-1500
Speed	25-30	35-40	45-50	55-60

- Avoid urgent speed up.
- Should replace oil of crankcase and gear oil after meshing.

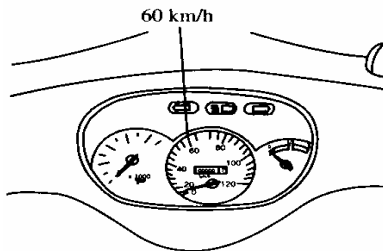

■ USING THE FRONT AND REAR BRAKING AT THE SAME TIME WHEN BRAKING

- Braking it after turn the throttle previous place.
- Should slow brake it firstlv and draw it.

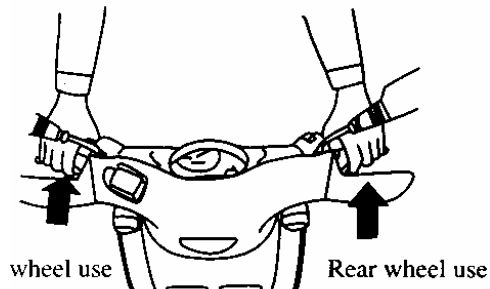

NOTICE

- Make the vehicle unsteady and slick by using one braking, so pay attention to it.

■ Forbid to brake and swerve urgently

- Braking urgently and swerve urgently are clause of lean and very dangerous.



■ Pay attention to driving in wet day

- The road in wet is different from sun day, the resis-tance of braking will draw long , should reduce speed .
- When down climb, return the throttle to closing place, and constantly brake with slowly moving.



■ WAY OF SPARKING

1 When approach the sparking place

- Open turn signal and notice rear, and slowly stop the vehicle.
- Return the throttle to previous place and brake front and rear braking, at the same time rear brake light is switched on and warn rear vehicle appears.

NOTICE: As the vehicle lean too much will make the idle speed instability.

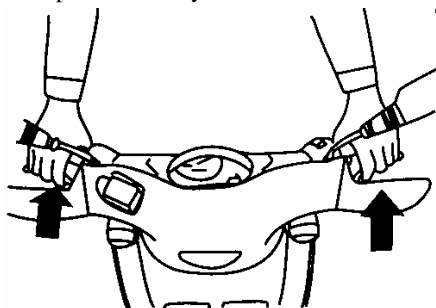

2 WHEN THE VEHICLE STOPS FULL

- Return the turn signal switch to previous place, and wrench the main switch to “”.

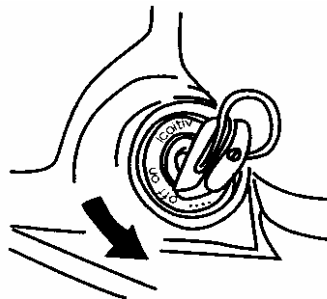

NOTICE

- When driving , if shut off main switch and take out the key, the electric system will not work, this is one clause , so operate it when sparking.

3 WHEN SPARKING

support the main stand.

- Support the main stand in the smooth ground.
- The left hand catches hold of handle bar, the right hand draws side rod under seat. The right foot step main stand and right hand draw urgently.

4 Should lock steering handle in order to theft, and take out key.

(Please reference for page 12

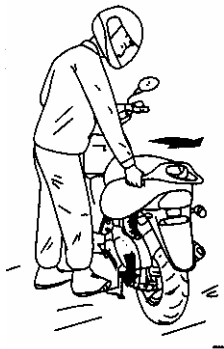

5. Check before driving

■ check before driving

Please have a habit of checking before driving.

Must active checking in order to safety and avoid to happen to accident and troubles.

Must check it before driving, if has question, please contact with the dealer.

■ Check and add up oil

1. Support the frame and take out oil lever to clear.

2. Insert into the oil lever

3. Take out and check it, when oil liquid reach at the limit of under, please add up oil to the limit of upper.

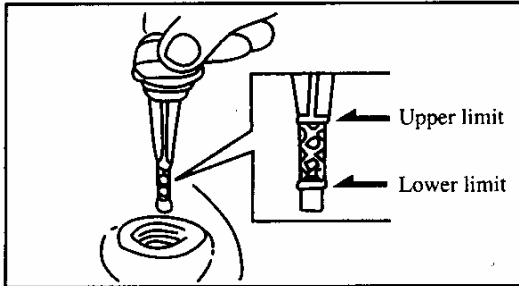

■ **APPOINT ESPECIALY OIL**

Four stroke, especially oil : SAE10W-30

NOTICE

1. There have a lot of dummy oil and make a mistake for using to happen trouble .
2. In order to assure your vehicle safety, please safely drive it per as stated and requirement.

1 CHECKING AND ADDING UP FOR OIL

- Should add up oil when fuel meter hand shows red area.
- Please add up #90 oil in time.
- Capacity of fuel tank : 5L

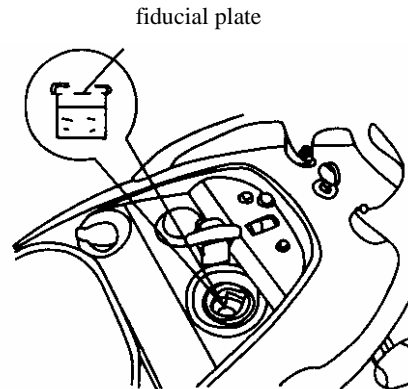

NOTICE :Please burn out when open fuel tank cover and forbid smoke

NOTICE

- Must turn off engine when add up oil.
- Insert the key and turn counter clock about 1/4 cycle till open fuel tank cover.
- When close cover of fuel tank, make the “ ” into lever with pole of oil.
- When add up oil, the lever of oil doesn't exceed standard oil, if not, the oil will leakage.

2 Checking steering bar

- Confirm whether upper and under, front and shaking loose.
- Confirm whether it has urgently conditions.
- Confirm whether it has crushing conditions.
- Please contact with the dealer and services if you find troubles.

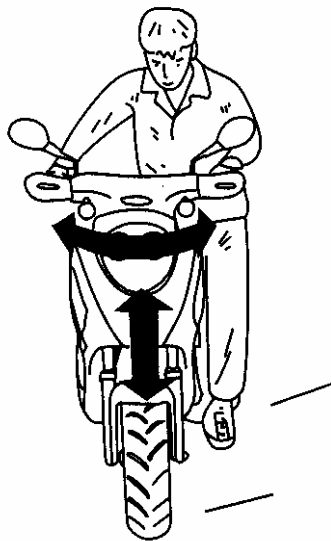

3 CHECKING BRAKING

<CLEARANCE OF BRAKING ROD>

The braking rod must have proper clearance. It has a proper clearance between checking rod to relaxing rod. The proper clearance which the rod work as normal. Check whether rod of braking clearance is the range between 1-2 cm

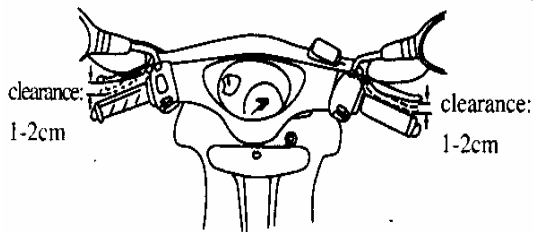

<checking for front braking liquid>

1. Make the handle bar well and check the capacity of oil in right fuel tank, which keep at the lever between the limit of upper and under.
2. Should check abrasion of braking rubber when the lever of liquid approach the limit of under.
3. If the rubber of braking is worn and not exceed limit stated, which shows condition of leakage oil, please you contact with dealer.
4. Recommend oil: DOT3

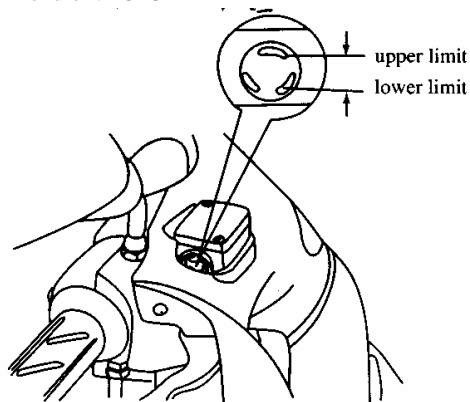

<ADJUSTING FOR REAR BRAKING>

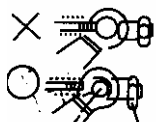
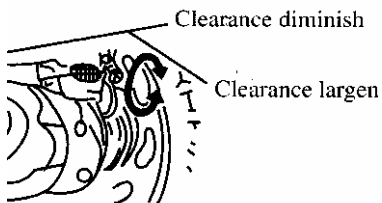

Piston Adjusting Nut

IS THE FUNCTION OF
BRAKING EXCELLENT?

Confirm the function of front
and rear braking through
slowly move.



4 Checking for braking light

- Turn the main switch to the “”
- Start the front and rear braking and confirm whether the braking light is switched on.
- Check whether the braking light is broken and dusty.

Tail light/ braking light

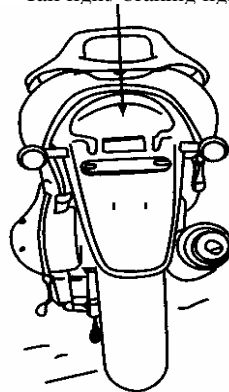

5 Checking for turn signal

- turn main switch to “  ”.
- Switch of turn signal can confirm whether all turn signal are switched on.

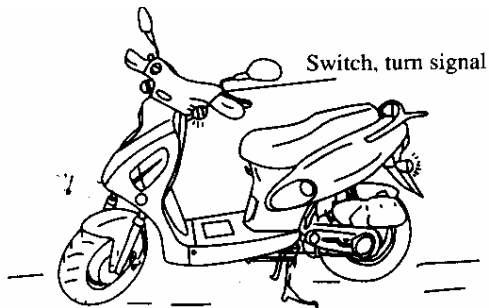

6 Checking for wheel

- Is the air pressure of wheel usually ?

Natural pressure

Front wheel.....196Kpa

Rear wheel.....221Kpa

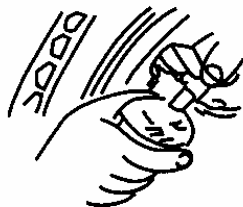

(air pressure of wheel)

- If the trough of wheel has miner pieces, and crushes, please you clear out them.
- When the chap or trough of wheel is abrasion to the deep, please replace the old tire.

(Please reference drawing)

(Sheet metal, Groveland impurity)

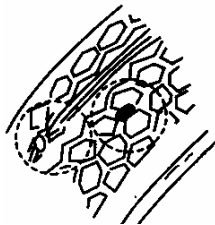

(abrasion limit showing)

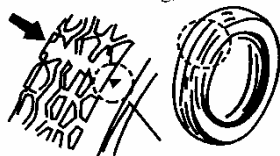

7 Checking for front and rear damper

Make weight into the handle bar and seat, shaking them and confirm the damper good.

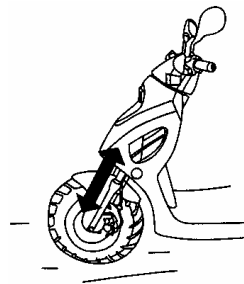

8 Headlight, taillight and sidelight are switched on

Confirm whether it has broken and dusty.

9 THE FUNCTION OF SPEEDOMETER HAND

- Should please you maintain the vehicle usually in order to assure to safely drive.

10 DOES THE HORN NOISE?

Put down “” and the horn will noise.

- When don't use it long before, please too maintain usually it.

11 Is the angle of rear mirror proper?

- The first checking

Seat on the vehicle and confirm and check whether it has broken dusty.

- Should please you check and maintain it the period of new using month or driv-ing in 300km.

12 Is the rear number plate dusty?

Check the number plate is broken and dusty.

13 Is different to exhaust?

Check the exhaust of pipe has broken and loosen.

14 All others

■ CHECKING FOR SPLINE OF REAR WHEEL AND LOCKED OF FRONT AND REAR HANGER

- Supports the vehicle with main stand when check the spline of rear wheel , drawing up the side of rear tire, and confirming whether it fell like loose.
- Care fully check whether the front and rear hanger system is locked.

■ CHECKING FOR AIR CLENER

- The air cleaner adopts paper score and checks it every 200km.
- Replace it every 5000km.

NOTICE

- Please clear out or replace oil as follows conditions
- Drive in the wet days.
- Drive on the dusty or terrible road.

■ Replace the oil

Replace the oil first driving in 300km, and replace it every 1000 later. Check the capacity of oil every 500km and in time add up the oil to standard lever.The total of capacity :0.9L, and normal is 0.75L.

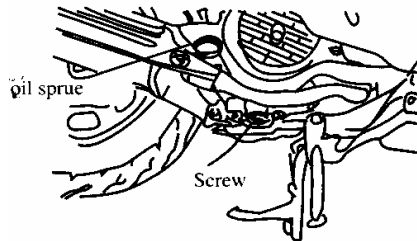

NOTICE: PLEASE REPLACE USUALLY OIL AND KEEP THE USAGE TOO LONG.

■ REPLACE GEAR OIL

<The period of replace>

Replace gear oil in the period of 300km, every half a year or 300km later with 10# or GY gear oil.

The capacity of gear oil

- All capacity :0.11L

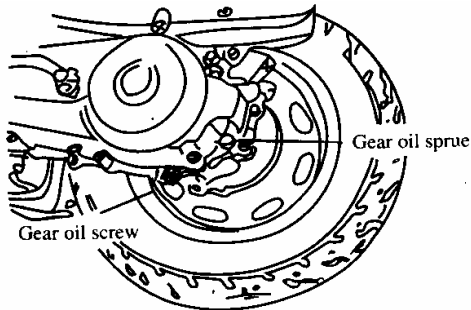

<Ways of changing>

- 1.Support the vehicle on the smooth ground.
- 2.Take out letting and pouring screws.
- 3.Don't run the warm engine, if not, the remain oil will out or fuel tank.
- 4.Clear out and lock the letting screw.
- 5.Make the oil into the fuel tank till the under lever of o-hole.
- 6.Lock the screw.

NOTICE

- Replace gear oil usually, as follows:
- Drive in the wet day.
- Drive too long.
- Overtake to drive.

■ CHECKING FOR SPARK PLUG

The pole of spark plug and too large clearance will make fair not full.

<Ways of cleaning>

The best way is using for cleaning machine of spark plug.

Can clear out it with needle brush if has not clearing machine.

<Adjust>

- Clearance of side pole normal 0.6-0.7mm.

(reference for drawings)

<Appointed spark plug>

C7HSA(NGK)

U22FS-U(ND)

NOTE: DON'T USE THE SPARK PLUG WHICH CANT BE APPOINTED.



NOTICE

- PAY ATTENTINO NOT TO BEING DAMAGED BE-CAUSE OF HIGH TEMPER ATURE OF ENGINE.
- WRIST INTO SPARK PLUG WITH HANDS AND WRENCH.

6.SIMPLY MAINTAINN AND ADJUSTING

Please check the result of excellent.

NOTICE ITEM:

Pay attention to safety

- Support the vehicle on the smooth ground.
- Operate with proper tools.
- Operate it in the condition of stopping.
- Pay attention not to being scolded because of high temperature of engine.

MAINTAINING ITEMS AND STABLE

Should check and maintain it in order to assure to safely drive, keep performance, extend usage and reduce pollution.

1. Checking, if possible clearing, lubrication, adjusting or replacing A adjusting R: replacing T lock.

Items	MILEVGE(km)													Check before driving
	300	1000	2000	3000	4000	5000	6000	7000	8000	9000	10000	11000	12000	
Engine oil	R	R	R	R	R	R	R	R	R	R	R	R	R	1
IOil web	C				C					C			C	
Gear oil	R			R			R			R			R	
Spark plug														
Valve clearance in 0.12 out0.12		A			A				A				A	
Chain		A			A				A				A	
Carburetor					1				1				1	
Air cleaner	Cleanout filter core every 2000 km, change every 5000km.													
Battery electrolyte		1	1	1	1	1	1	1	1	1	1	1	1	1
Fuel web	Cleanout every 1000km, change if need.													
Oil pumb	1				1				1				1	
Braking system		1	1	1	1	1	1	1	1	1	1	1	1	1
Drive belt														
All parts screws	T					T						T		
Waste air depth	Check frequently, adjust, Avoid polluting air													
*the above items will change because of different from the kind of vehicle .														
*The mileages are exceed the above stable , please active per as.														
*When drive in the dusty area, please clear out the score usually														

■ CHECKING FOR BATTERY ELECTROLYTE

1 The vehicle obtain non-adding water bat-tery or Please take down the three screws of cover adding up electrolyte battery.

When sue the non-adding water battery, don't need add and check.

NOTIE

- Forbid to open the cover of close battery electrolyte
- Don't use it, please take down and place it the cold area
- Please take down the cable don't use it long before

When use the adding up battery, keep the lever of oil the limit between the upper under



2 Head of battery

Please take down the three screws of cover of battery for step when clear head of battery, open cover of battery.

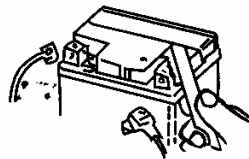
- Take down and clear out the battery when the head of battery is abrasion.
- paint a group of buttery or Vaseline in the head of battery



NOTICE

- Close off main electric resource, and take down  when taking apart; when assembling, fix or  and 
- Should lock it when the screw of head battery becomes loose.

■ REPLACE FUSE

Shut off main switch and check whether the fuse is broken

Replace the fuse as per stated.

*Please check the clause of broken and replace it.

*Open cover and the fuse in the fuse case.

*Draw up the o-clip.



Wire harness

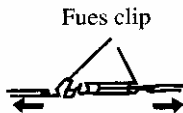

Fuses clip



Insert
Fix on

- Replaces the electric goods, please use the appointed

- station specification parts.

- Forbid to use the not-specification goods .

Avoid rush it with water, when clear out.

NOTICE

- When taking down, don't extend the ring clip too large.

- When assembling, confirm whether clip of guide ring loose, if has, please maintain it .

- Doesn't use the fuse which is not specification, if not will happen damage.

■WAY OF CLEANING FOR AIR CLEANER

Too much dusty is one of the cause to reduce power.

(WAY FOR TAKING DOWN)

- 1.Please locked screws
- 2 .Take down air cleaner cover and are cleaner.
- 3.Take down two locked screws of air cleaner.
- 4.Replace score of air cleaner.

(Ways of fixing)

- When takes down , please do it as per the object.

NOTICE

- If the air cleaner doesn't fix, the dusty will into cylinder, and make effect on power low and usage of engine.
- When clear out, air cleaner cant be wet.

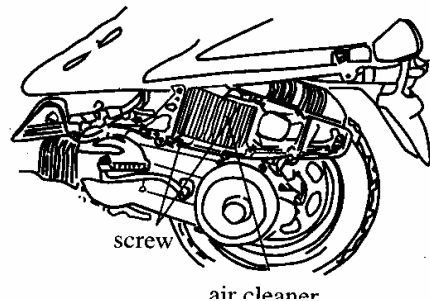
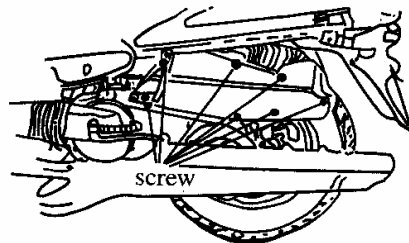

NOTE:Please let out remainv oil in red tube every 1000km

■ ADJUSTING FOR CHOKE AND CARBURETOR

Steady steam function is the basis of good performance of engine , so don't freely change it, you only adjust it as follows :adjust choke and idle speed.

(a) adjust choke

1.Check whether work of choke is orderly.

2.Check the clearance of choke is 2-6mm, if adjust it you only adjust nut (1) and adjuster (2) Torque adjustment.

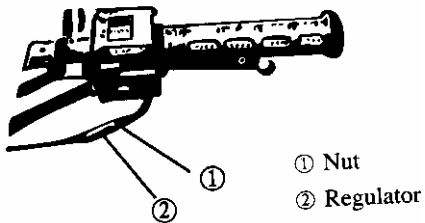

b) adjust idle speed

1.should warm up the engine.

2.adjust it till the need of requirment.

7. Specification schedule

SIZE AND WEIGHT	OVERALL LENGTH mm	1890	POWER EQUIPMENT	CLUTCH TYPE	AUTOMATIC ACCIDENTED	
	OVERALL WIDTH mm	720		WHEEL SIZE	FRONT	3.50-10
WEIGHT	OVERALL HEIGHT mm	1055		TYPE	REAR	3.50-10
	WHEEL BASE mm	1300			FRONT	PLAT/DRUM
	GROUD LEAVE mm	105		REAR	DRUM	
	FRAME WEIGHT kg	96		HANGER TYPE	FRONT	COLLAR
	ENGINE TUPE	LB147QMG		REAR	SEWING ARM	
ENGINE	TOTAL CAPACITY L	100.2		CUSHION TYPE	FRONT	OIL DAMP
	BORE*STROKE mm	47×57.8		REAR	OIL DAMP	
	COMPRESS RATIO	9.4:1		HEAD LIGHT	12V 35W/35W	
	STARTING SYSTEM	ELECTRIC/KI CKSTARTING		SIDELIGHT	12V10W	
	LUBRICATING SYSTEM	FORCED LUBRICATING		TURN SIGNAL/ SIDELIGHT		
	E/GLUBRICATING CAPACITY L	1.1		TURN SIGNAL	12V 10W	
	FUEL	FUEL TANK CAPACITY L		4	TAIL LIGHT BRKING LIGHT	12V 18W/5W
ELETRIC EQUIPMENT	SPARKPLUG TYPE			SPEEDOMETER LIGHT	80(km/h)	
	BATTERY CAPACITY	12V7AH		HEAD LIGHT	140(kg)	